

WELCOME TO
CONNECT



SILVELOX
GROUP SPA

**CREIAMO SOLUZIONI UNICHE CON MAESTRIA ARTIGIANALE
COME OPERE D'ARTE CHE ARRICCHISCONO GLI AMBIENTI.**

WE STRIVE TO ENRICH LIVING ENVIRONMENTS WITH UNIQUE
SOLUTIONS THAT REFLECT CRAFTSMANSHIP MASTERY.

NOUS CRÉONS DES SOLUTIONS UNIQUES AVEC UN
SAVOIR-FAIRE ARTISANAL COMME DES ŒUVRES D'ART QUI
ENRICHISSENT LES ENVIRONNEMENTS.



**65 ANNI DI PASSIONE PER LA MANIFATTURA,
RICERCA DELLA QUALITÀ IN LINEA CON LA
TRADIZIONE ITALIANA.**

65 YEARS OF DEDICATION ON MANUFACTURING,
RESEARCH OF QUALITY INSPIRED BY OUR ITALIAN
ROOTS AND TRADITION.

65 ANS DE PASSION POUR LA FABRICATION,
LA RECHERCHE DE LA QUALITÉ DANS LE RESPECT
DE LA TRADITION ITALIENNE.



CASTELNUOVO (TN)
HEADQUARTERS AND PRODUCTION PLANT

Rappresentiamo l'eccellenza nella realizzazione di porte per garage, porte d'ingresso blindate, portoni ad ante e sistemi d'architettura. Ci distinguiamo per la capacità di creare soluzioni inedite in cui le più innovative tecnologie antieffrazione incontrano la massima cura per il design, i materiali e le finiture. Insieme ad una particolare attenzione per il risparmio energetico e l'abbattimento acustico. Offriamo un vasto catalogo in continuo sviluppo proponendoci sul mercato globale come fornitore attento e puntuale capace di sviluppare soluzioni completamente customizzate.

We excel in the creation of garage doors, security main entrance doors, heritage entrances and architectural coverings. Our products embed a great blend of technological innovation, acustic and thermal insulation, materials and finishings to define a certain design unicity. Our catalogue is always evolving in a global scenario where we committ to play as a accountable supplier customer centered.

Nous représentons l'excellence dans la fabrication de portes de garage, de portes d'entrée blindées, de portes cochères et de systèmes architecturaux. Nous nous distinguons par notre capacité à créer des solutions inédites dans lesquelles les technologies anti-effraction les plus innovantes rencontrent le plus grand soin pour le design, les matériaux et les finitions, ainsi qu'une attention particulière à l'économie d'énergie et à l'affaiblissement acoustique. Nous offrons un vaste catalogue en développement continu, nous présentant sur le marché mondial comme un fournisseur attentif et ponctuel capable de développer des solutions entièrement personnalisées.



REMEDELLO (BS)
PRODUCTION PLANT



IN_WALL INTONACATA RASOMURO INTERNO . RAL 9016
IN_WALL PLASTERED, FLUSH WITH INTERNAL WALL . RAL 9016
IN_WALL PLÂTRÉE AFFLEURANTE INTÉRIEUR . RAL 9016



SECUR + W_CONCEPT + IN_WALL . ONDULE . RAL 6017
SIKURA, SECUR, W_CONCEPT. ONDULE' LACQUERED. RAL 6017
SIKURA + SECUR + W_CONCEPT. ONDULÉ . LAQUÉ RAL 6017

**UN MARCHIO SINONIMO
DI ECCELLENZA E PRESTIGIO.**

A BRAND WHICH INSPIRES
EXCELLENCE AND PRESTIGE.

UNE MARQUE SYNONYME
D'EXCELLENCE ET DE PRESTIGE.

SILVELOX GROUP: UNA GAMMA COMPLETA DI PORTE BLINDATE, PORTE GARAGE, PORTONI AD ANTE, CHIUSURE INDUSTRIALI E COMPONENTI BREVETTATI PER GARAGE.

SILVELOX GROUP: A COMPLETE RANGE OF GARAGE DOORS, SECURITY ENTRANCE DOORS, HERITAGE DOORS, INDUSTRIAL DOORS AND PATENTED COMPONENTS FOR GARAGE DOORS.

LE GROUPE SILVELOX: UNE GAMME COMPLÈTE DE PORTES BLINDÉES, PORTES DE GARAGE, PORTES COCHÈRES, FERMETURES INDUSTRIELLES ET COMPOSANTS BREVETÉS POUR PORTES DE GARAGE.

SILVELOX
GROUP SPA

SILVELOX
OPEN YOUR SPACE

IL MARCHIO DI ECCELLENZA PER IL RESIDENZIALE
OFFERING EXCELLENCE WITHIN THE RESIDENTIAL MARKET
LA MARQUE D'EXCELLENCE POUR LE SECTEUR RÉSIDENTIEL

SEIP
PROFESSIONAL DOORS

IL MARCHIO DELLA GAMMA DI PORTE INDUSTRIALI
OFFERING SOLUTIONS INDUSTRIAL DOORS
LA MARQUE DE LA GAMME DE PORTES INDUSTRIELLES

Composeip®

IL MARCHIO DEI COMPONENTI PER PORTE GARAGE
PROVIDING COMPONENTS FOR GARAGE DOORS
LA MARQUE DES COMPOSANTS POUR PORTES DE GARAGE

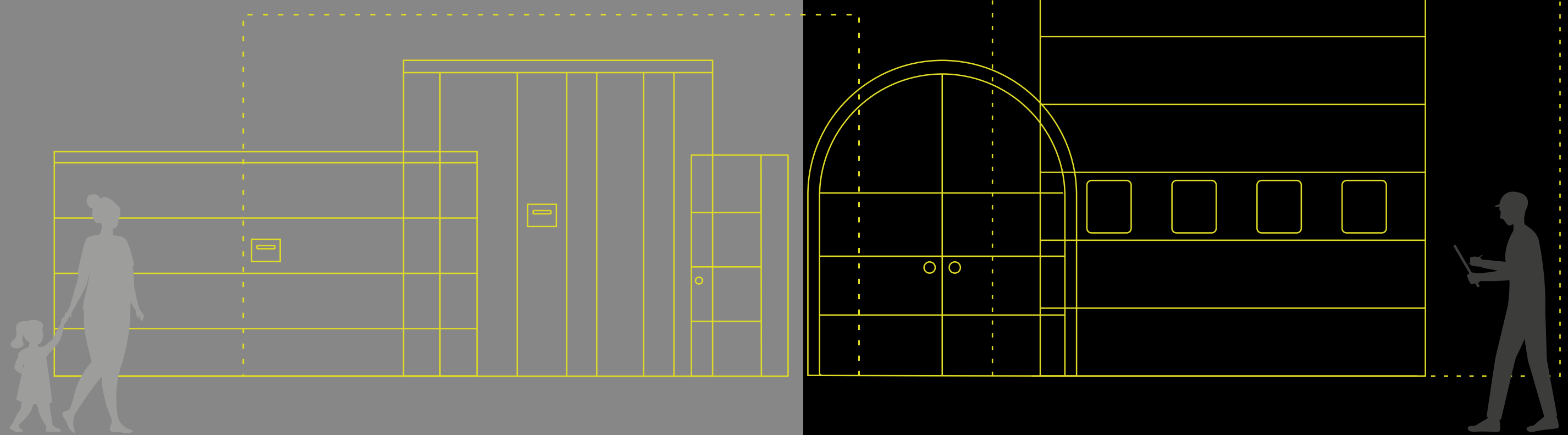

SILVELOX
OPEN YOUR SPACE

SEIP
PROFESSIONAL DOORS

LA NOSTRA FORZA.
OUR STRENGTH.
NOTRE FORCE.

1961

**FONDAZIONE
DI SILVELOX**

SILVELOX
FOUNDATION
FONDATION
DE SILVELOX

2007

**FONDAZIONE
DI SEIP**

SEIP
FOUNDATION
FONDATION
DE SEIP

2019

**NASCITA DI
SILVELOX**

GROUP SPA BIRTH OF
SILVELOX GROUP SPA
NAISSANCE SILVELOX
GROUP SPA

3

**SEDI
PRODUTTIVE**

MANUFACTURING
PLANTS
SITES DE
PRODUCTION

120

**PERSONE
IMPIEGATE**

PEOPLE
EMPLOYED
PERSONNES
EMPLOYÉES

30 **MILIONI DI EURO**
MILLION EUROS
MILLIONS D'EUROS

GIRO D'AFFARI

TURNOVER
CHIFFRE D'AFFAIRE

13500

**PORTE
PRODOTTE**

DOORS
MADE
PORTES
PRODUITES

4

**LINEE DI
SOLUZIONI
INDUSTRIALI**

INDUSTRIAL
DOORS LINES
LIGNES DE
SOLUTIONS
INDUSTRIELLES

8

**LINEE DI
PORTE
GARAGE**

RESIDENTIAL
DOORS LINES
LIGNES DE PORTES
DE GARAGE

11

**LINEE DI
PORTE
BLINDATE**

SECURITY
DOORS LINES
LIGNES DE PORTES
BLINDÉES

PRODUZIONE MADE IN ITALY.
 PRODUCTION MADE IN ITALY.
 PRODUCTION MADE IN ITALY.



Nello stabilimento di Castelnuovo avviene tutta la produzione, dalla preparazione dei semilavorati in legno, all'ingegnerizzazione specifica di ogni componente, fino all'assemblaggio delle parti meccaniche ed elettriche, una garanzia della qualità dei prodotti Silvelox. Nello stabilimento di Remedello avviene l'assemblaggio delle porte sezionali e a libro e portoni industriali, detenendo la proprietà formale e intellettuale del know-how in ambito tecnico, di progettazione e di produzione di componenti, accessori e profili; garantendo uno standard qualitativo unico.

In Castelnuovo the complete timber technology works takes place, the R&D project all our solutions and products are manufactured, assembled and tested. In Remedello we develop components and parts for the assembly of sectional doors, industrial doors granting high quality standards.

Toute la production a lieu dans l'usine de Castelnuovo, de la préparation des produits semi-finis en bois, à l'ingénierie spécifique de chaque composant, jusqu'à l'assemblage des parties mécaniques et électriques, une garantie de la qualité des produits Silvelox. L'assemblage des portes sectionnelles et pliantes et des portes industrielles a lieu dans l'usine de Remedello, qui détient la propriété formelle et intellectuelle du savoir-faire en matière de technique, de conception et de production de composants, d'accessoires et de profilés, garantissant ainsi un standard de qualité unique.

UN NETWORK INTERNAZIONALE.
 INTERNATIONAL NETWORK.
 UN RÉSEAU INTERNATIONAL.



- Operiamo in Inghilterra, Francia, Spagna, Portogallo, Germania, Polonia, Ungheria, Romania, Slovenia, Lussemburgo, Paesi Arabi, Giappone, Cina e Israele con potenzialità di crescita globale, anche attraverso Silvelox USA e Seip do Brasil, sede produttiva.

We deliver our solution throughout Europe, overseas to Japan, Cina, the GCC and operate via Silvelox USA and Seip do Brasil serving South America as manufacturing location.

Nous sommes présents au Royaume-Uni, en France, en Espagne, au Portugal, en Allemagne, en Pologne, en Hongrie, en Roumanie, en Slovénie, au Luxembourg, dans les pays arabes, au Japon, en Chine et en Israël, avec un potentiel de croissance mondiale, notamment par le biais de Silvelox USA et de Seip do Brasil, site de production.



RISPETTIAMO L'AMBIENTE E IL FUTURO DELLE NUOVE GENERAZIONI.

WE RESPECT THE ENVIRONMENT AND THE FUTURE OF THE NEW GENERATIONS.

NOUS RESPECTONS L'ENVIRONNEMENT ET L'AVENIR DES NOUVELLES GÉNÉRATIONS.



ECONOMIA CIRCOLARE
CIRCULAR ECONOMY
ÉCONOMIE CIRCULAIRE

Abbiamo adottato un sistema di riutilizzo dei materiali di scarto che viene definito economia circolare, un sistema economico pianificato per riutilizzare i materiali in successivi cicli produttivi, riducendo al massimo gli sprechi. Oltre a questo: illuminazione a Led in entrambi gli stabilimenti, pannelli solari che generano 700.000 kw/anno (corrispondenti a un risparmio di 460 Ton di gas terra e 210 Ton di gasolio) e utilizzo di vernici ad acqua. Stiamo lavorando al «Bosco di Silvelox».



AMORE PER IL TERRITORIO
CARE FOR OUR TERRITORY
L'AMOUR POUR LE TERRITOIRE

We have created a production ecosystem where scrap materials are recycled within the manufacturing cycle. Besides this our units are equipped with LED lights, solar panels to generate 700.000 kw/year that corresponds to a saving of 460 Tons of gas and 210 Tons of gasoline. All the paints used in our varnishing processes are water based. We have generated our "Silvelox" Wood.



ENERGIA GREEN E RINNOVABILE
POWER RENEWABLE
POUVOIR RENOUELABLE

Nous avons adopté un système de réutilisation des déchets qui est défini comme économie circulaire, un système économique planifié pour réutiliser les matériaux dans les cycles de production ultérieurs, en réduisant les déchets au minimum. En outre, les deux usines sont éclairées par des LED, des panneaux solaires produisent 700 000 kw/an, ce qui correspond à une économie de 460 tonnes de gaz naturel et de 210 tonnes de diesel, et des peintures à base d'eau sont utilisées. Nous travaillons sur la "forêt Silvelox".



**SOSTENIAMO L'ARTE E LA BELLEZZA.
SIAMO PARTNER DI ARTESELLA.**

AS SPONSOR OF ARTESELLA WE CARE
FOR ART AND THE BEAUTY OF OUR TERRITORY.

EN TANT QUE SPONSOR DE ARTESELLA,
NOUS SOUTENONS L'ART ET LA BEAUTÉ
DE NOTRE TERRITOIRE.



È positivo vedere come Silvelox Group sostenga e valorizzi Arte Sella, un progetto artistico così unico e affascinante. Arte Sella rappresenta davvero un'opportunità straordinaria per gli artisti di esplorare la connessione tra creatività e natura, il fatto che più di 300 artisti abbiano contribuito all'evoluzione di questo progetto nel corso degli anni è testimonianza del suo significativo impatto nella comunità artistica.

L'impegno di Silvelox Group nel sostenere iniziative culturali come Arte Sella dimostra un forte senso di responsabilità sociale e una profonda connessione con la comunità e la cultura locale.

It's positive to see how Silvelox Group supports and values Arte Sella, such a unique and fascinating artistic project. Arte Sella truly represents an extraordinary opportunity for artists to explore the connection between creativity and nature, and the fact that over 300 artists have contributed to the evolution of this project over the years is a testament to its significant impact in the artistic community.

Silvelox Group's commitment to supporting cultural initiatives like Arte Sella demonstrates a strong sense of social responsibility and a deep connection to the local community and culture.

C'est positif de voir comment Silvelox Group soutient et valorise Arte Sella, un projet artistique si unique et fascinant. Arte Sella représente vraiment une opportunité extraordinaire pour les artistes d'explorer le lien entre la créativité et la nature, et le fait que plus de 300 artistes aient contribué à l'évolution de ce projet au fil des ans témoigne de son impact significatif dans la communauté artistique.

L'engagement de Silvelox Group à soutenir des initiatives culturelles comme Arte Sella démontre un fort sens de la responsabilité sociale et un lien profond avec la communauté et la culture locales.

IL LEGNO, AL CUORE DI OGNI NOSTRO PRODOTTO.

TIMBER, HEART OF ANY OF OUR PRODUCTS.

LE BOIS, AU CŒUR DE CHACUN DE NOS PRODUITS.



Il legno è la materia prima che dà origine a tutte le nostre porte: selezioniamo le migliori essenze per garantire qualità estetica, massime performance tecniche e resistenza agli agenti atmosferici e al trascorrere del tempo.

Timber is at heart of our creations. We select the best essences to grant esthetic appeal, great technical performances obtaining high durability and resistance to atmospheric agents.

Le bois est la matière première qui donne naissance à toutes nos portes: nous sélectionnons les meilleures essences de bois pour garantir la qualité esthétique, les performances techniques maximales et la résistance aux intempéries et au temps.

LAVORAZIONE METALLI, SALDATURA AUTOMATIZZATA, CICLO DI VERNICIATURA INTERNA.

METAL CARPENTRY. WE ARE EQUIPPED TO PROCESS METAL ELEMENTS FROM AUTOMATED WELDING AND THE COMPLETE POWDER COATING CICLE.

TRAVAIL DU MÉTAL, SOUDURE AUTOMATISÉE, CYCLE DE PEINTURE INTERNE.



Risolviamo i problemi progettandone la soluzione. Il nostro know how ci permette di affiancare il cliente e trovare la migliore strategia per le sue esigenze progettuali, studiando i requisiti tecnici e funzionali, definendo soluzioni ad hoc, garantendo risposte per ogni tipo di progetto.

Markets are always challenging and we endeavour at our best to face them with passion. We stand by our client to help discovering the most appropriate solution by analyzing projects technical or esthetical requirements and defining the best suiting application.

Nous résolvons les problèmes en concevant leur solution. Notre savoir-faire nous permet d'accompagner le client et de trouver la meilleure stratégie pour ses besoins de conception, d'étudier les exigences techniques et fonctionnelles, de définir des solutions personnalisées, garantissant des réponses pour chaque type de projet.

**ACCIAIO, RAME, CORTEN, GRES PORCELLANATO,
ARENARIA, LACCATO, ALLUMINIO, VETRO.**

STEEL, COPPER, CORTEN, PORCEALIN, SANDSTONE,
GLASS, ALUMINUM.

ACIER, CUIVRE, CORTEN, BOIS MASSIF EN ESSENCE,
GRÈS CÉRAME, LAQUÉ, ALUMINIUM, VERRE.

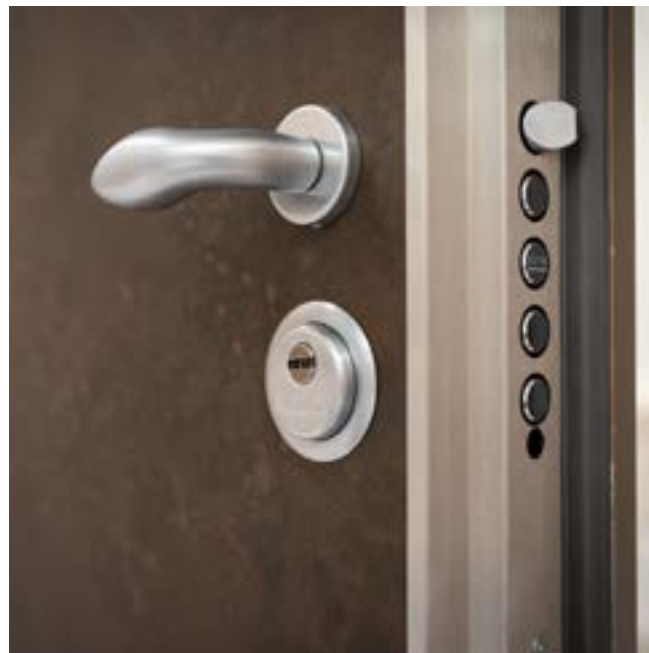

Ci teniamo al passo con le ultime tendenze in fatto di design, applicazioni e costruzioni, collaborando con famosi architetti e università. I materiali sono sviluppati per adattarsi a diverse applicazioni sia in interni che in esterni.

We keep up with the latest design, application, building trends by cooperating with famous architects and university. Materials are developed to adapt to several applications both indoor and outdoor.

Nous travaillons constamment à redéfinir le design de nos produits et à les pousser au-delà des dernières tendances, en collaborant avec des architectes de renom, des universités et en participant à des foires commerciales. Nos revêtements sont conçus pour s'adapter aux utilisations et aux conditions d'exploitation les plus diverses, tant à l'intérieur qu'à l'extérieur.

PRODOTTI UNICI, INFINITI DESIGN.

UNIQUE PRODUCTS, INFINITE DESIGN.

DES PRODUITS UNIQUES, DES DESIGNS INFINIS.

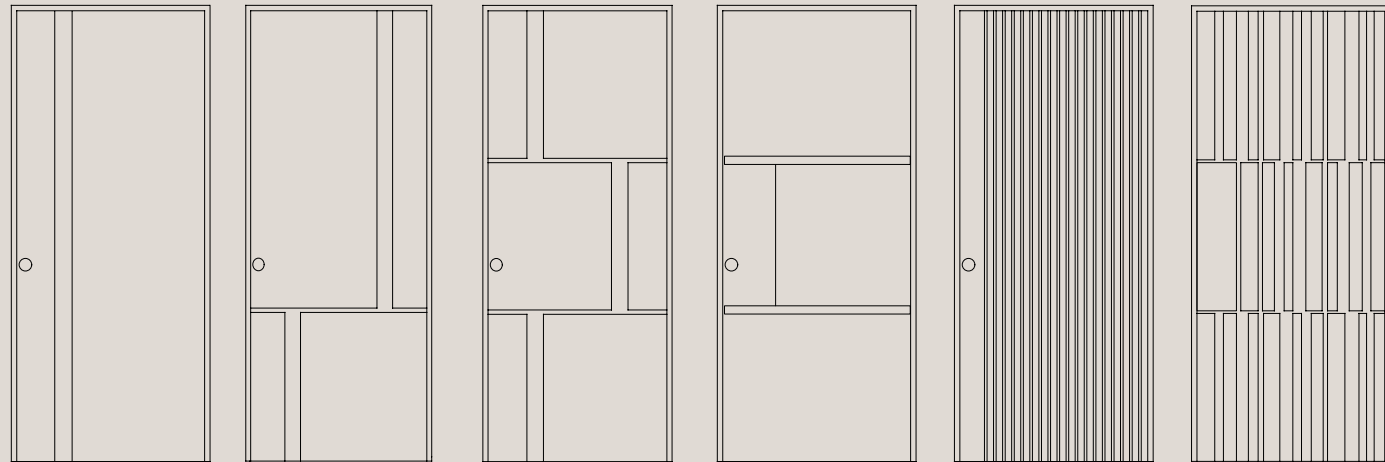

Le porte per garage, porte d'ingresso e le porte ad ante sono il frutto di una delle infinite combinazioni possibili di essenze, colori, disegni e accessori. Questa flessibilità è portata all'estremo nelle porte progettate su specifico disegno del cliente o dell'architetto. Per offrire ad ogni cliente la porta dei suoi sogni, in ogni dettaglio.

Doors are a combination of multiple materials application, colors, timber essences and components. We strive to merge all the elements together in a specific solution for the customer and his design team to obtain the desired details.

Les portes de garage, les portes d'entrée et les portes cochères sont le résultat d'un nombre infini de combinaisons possibles de bois, de couleurs, de motifs et d'accessoires. Cette flexibilité est poussée à l'extrême dans les portes conçues selon le projet spécifique du client ou de l'architecte. Offrir à chaque client la porte de ses rêves, dans les moindres détails.

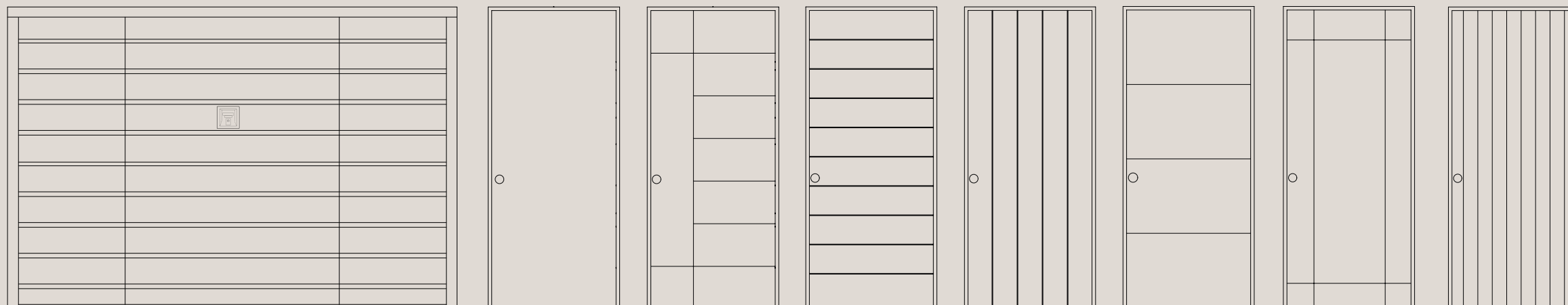
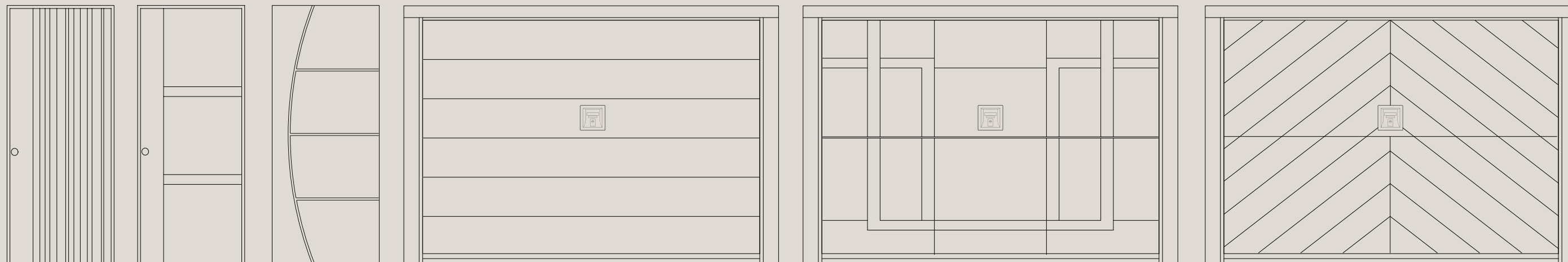

SISTEMI DI ACCESSO SENZA LIMITI.

LIMITLESS ACCESS SYSTEMS.

SYSTÈMES D'ACCÈS ILLIMITÉS.

Silvelox realizza sistemi d'accesso studiati per accrescere il prestigio e l'eleganza di tutte le abitazioni. Perfetta combinazione fra linee, forme e performance tecniche, risultato unico di un ricercato effetto estetico, elegante ed equilibrato.

Perfect combination among shapes, geometry, finishing, technical performances as the result of a refined esthetical effect, elegant and balanced.

Silvelox crée des systèmes d'accès conçus pour augmenter le prestige et l'élégance de toutes les maisons. Combinaison parfaite de lignes, de formes et de performances techniques, résultat unique d'un effet esthétique raffiné, élégant et équilibré.

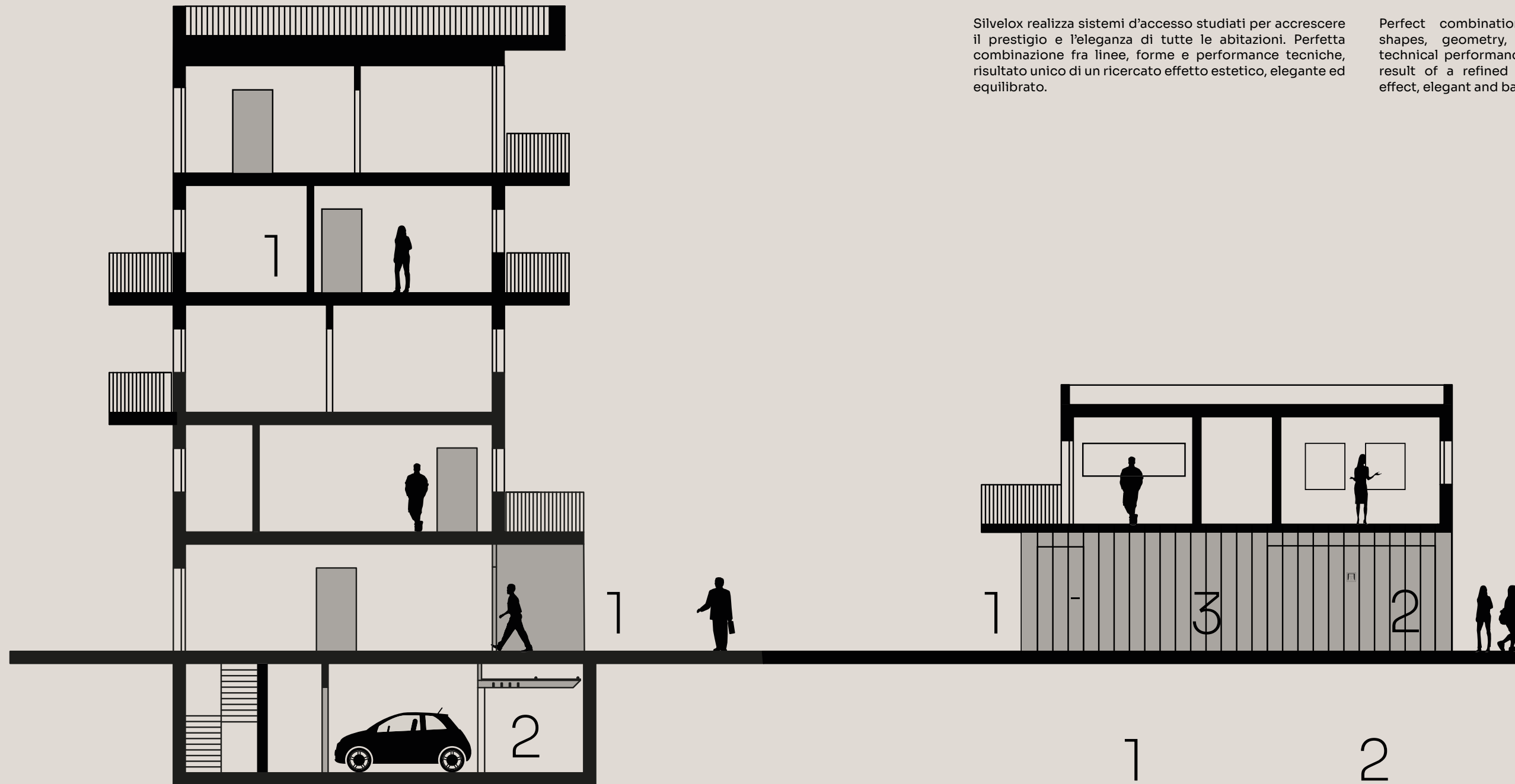

1
PORTE BLINDATE
SECURITY ENTRANCE DOORS
PORTES BLINDÉES

2
PORTE GARAGE
GARAGE DOORS
PORTES DE GARAGE

3
WALL CONCEPT
WALL CLADDING SYSTEMS
WALL CONCEPT

**GARAGE RESIDENZIALI:
SPAZI MULTIFUNZIONALI CON
VARIE ASPIRAZIONI.
8 MODELLI DI PORTE GARAGE.**

RESIDENTIAL GARAGE DOORS:
MULTIFUNCTIONAL LOCATIONS WITH
VARYING DESTINATION.
8 LINES OF GARAGE DOORS.

GARAGES RÉSIDENTIELS:
DES ESPACES MULTIFONCTIONNELS
AUX ASPIRATIONS VARIÉES.
8 LIGNES DE PORTES DE GARAGE.

BASCULANTI

CANOPY/UP-AND-OVER DOORS
BASCULANTEW

SECUR

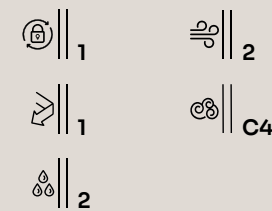
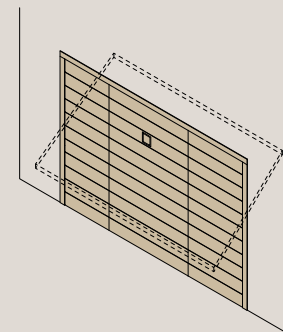

SECUR PLUS

BREVETTO INTERNAZIONALE
INTERNATIONAL PATENT
BREVET INTERNATIONAL

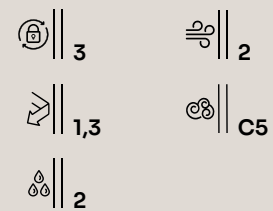
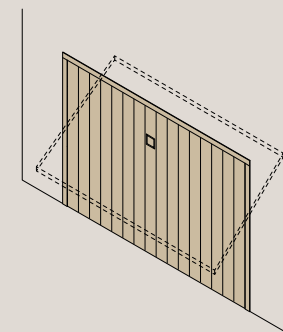

BASCULAP

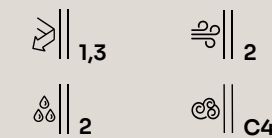
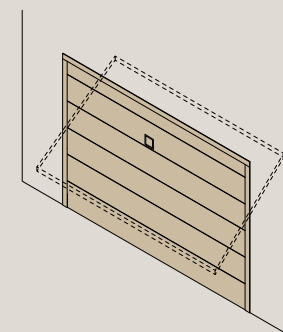

SEZIONALI

SECTIONAL DOORS
SECTIONNELLES

SR

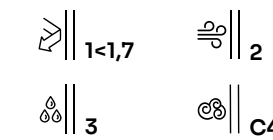
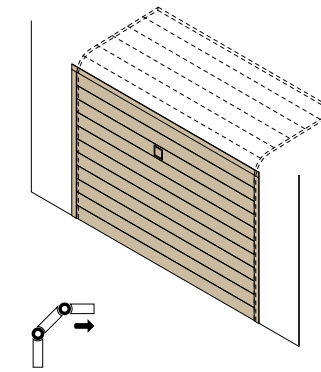

SLS

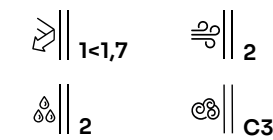
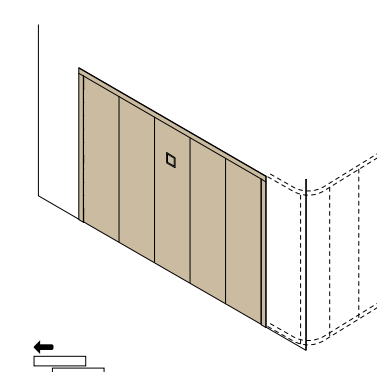

SLD

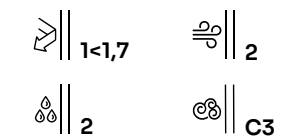
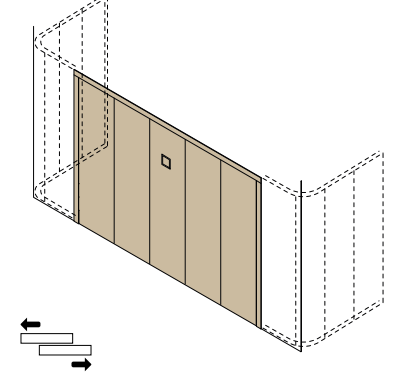

SECURLAP

NOSTRO BREVETTO INTERNAZIONALE OVERLAP
OUR INTERNATIONAL OVERLAP PATENT
NOTRE BREVET INTERNATIONAL OVERLAP

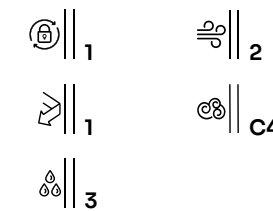
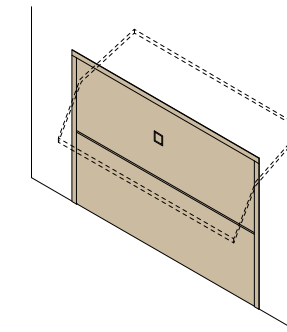

HISTORICO

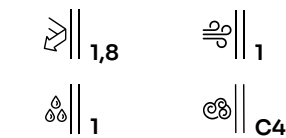
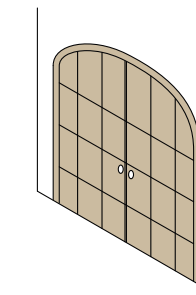

WALL CONCEPT

SOLUZIONI COMPLANARI
COMPLANAR SOLUTIONS
SOLUTION COPLANAIRES

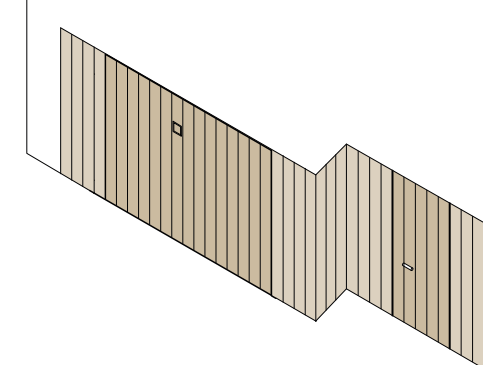

**UNA GAMMA DI PORTE PER GARAGE
UNICA E IN GRADO DI SODDISFARE SOLUZIONI
ARCHITETTONICHE ED ESTETICHE DIVERSE.**

A UNIQUE RANGE OF GARAGE DOORS
DO RESPOND TO ALWAYS VARYING
ARCHITECTURAL REQUIREMENTS.

UNE GAMME DE PORTES DE GARAGE
UNIQUE ET PERFORMANTE POUR SATISFAIRE
DIFFÉRENTES SOLUTIONS ARCHITECTORALES
ET ESTHÉTIQUES.



SECUR MILLERIGHE . ROVERE NATURALE . PORTA PEDONALE
SECUR MILLERIGHE . NATURAL OAK . PEDESTRIAN DOOR
SECUR MILLERIGHE . CHÊNE NATUREL . PORTILLON



BASCULAP PANNELLO RONDONIA . RAL 7016 . MANIGLIA SILVER
BASCULAP MOD. RONDONIA . RAL 7016 . SILVER HANDLE
BASCULAP RONDONIA . RAL 7016 . POIGNÉE SILVER



SECUR CON W_CONCEPT E PERSEO RIVESTITE LAMINAM
SECUR PERSEO . CUSTOM LAMINAM CLAD
SECUR PERSEO, REVÊTEMENT LAMINAM

**STILE E DESIGN TRA PORTA GARAGE
E PORTA D'INGRESSO.**

CONTINUITY BETWEEN GARAGE
AND THE ENTRANCE DOOR.

STYLE ET DESIGN ENTRE PORTE
DE GARAGE ET PORTE D'ENTRÉE.



WALL CONCEPT

Abbiamo coinvolto le due soglie classiche dell'edificio, la porta per garage e la porta d'ingresso, integrandole in un concetto più generale di rivestimento come trattamento unitario e qualificante dell'involucro architettonico e del suo basamento. Uno studio che si concretizza nel progetto Wall Concept.

Garage doors and Entrance doors are integrated within a wider cladding concept to qualify and customise the building envelop. A study that let us generate our Wall Concept system.

Nous avons impliqué les deux classiques du bâtiment, la porte de garage et la porte d'entrée, en les intégrant dans un concept plus général de bardage comme traitement unitaire et valorisant de la façade. Une étude qui se concrétise dans le projet Wall Concept.



SECUR E W_CONCEPT . GEO A DISEGNO . OKUME TINTA MIELE
SECUR AND W_CONCEPT . CUSTOM GEO . OKUME STAINED HONEY
SECUR ET W_CONCEPT, GEO SELON DESSIN, OKOUMÉ TEINTE MIEL



SECUR E PERSEO . CUSTOM . RAL 7047 . MANIGLIONE LOOP

**LE SOLUZIONI PER L'INDUSTRIA.
4 MODELLI DI CHIUSURE.**

INDUSTRIAL SOLUTIONS.
4 LINES OF CLOSURES.

LES SOLUTIONS POUR L'INDUSTRIE.
4 LIGNES DE FERMETURES.



**PORTONE
A LIBRO O
SCORREVOLE**
FOLDING DOOR
PORTE PLIANTE

LE . LN . LG . SN

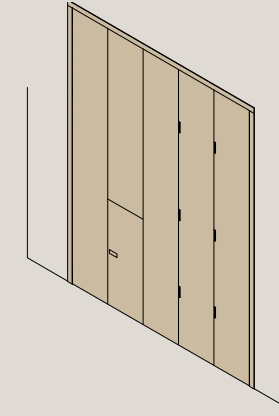

<1,3 4

**PORTONE
SEZIONALE**
SECTIONAL DOOR
PORTE SECTIONNELLE

SI . SM

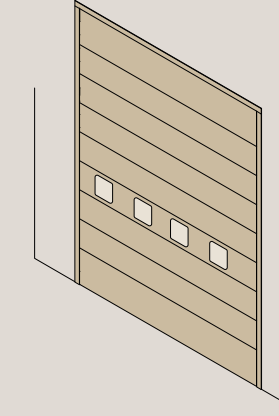

0,8<1,7 2
 3 4

**PORTA
RAPIDA**
HIGH SPEED DOOR
PORTE RAPIDE

RA . RI . R3 . R6

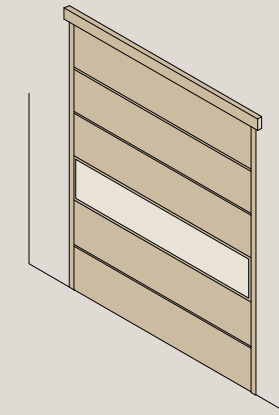

2

**SERRANDE
INDUSTRIALI**
INDUSTRIAL SHUTTERS
VOLETS INDUSTRIELLES

SC

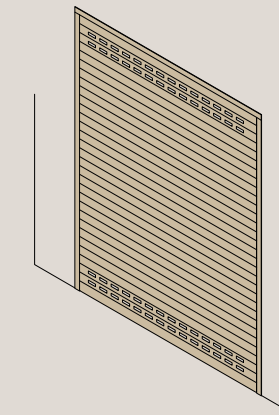

<1,3 3

**L'ECCEZIONALITÀ È IL NOSTRO STANDARD.
11 MODELLI DI PORTE BLINDATE.**

**EXCEPTIONALITY: OUR STANDARD.
11 LINES OF SECURITY ENTRANCE DOORS.**

**L'EXCEPTIONNALITÉ EST NOTRE STANDARD.
11 LIGNES DE PORTES BLINDÉES.**

ISOLAMENTO TERMICO
THERMAL INSULATION
ISOLATION THERMIQUE

TENUTA ALL'ACQUA
WATER TIGHTNESS
ÉTANCHÉITÉ À L'EAU

ANTIEFFRAZIONE
SECURITY
ANTI-EFFRACTION

RASO MURO
WALL FLUSHNESS
AFFLEURANT

TENUTA ARIA
AIR TIGHTNESS
ÉTANCHÉITÉ À L'AIR

TENUTA AL VENTO
WIND TIGHTNESS
ÉTANCHÉITÉ AU VENT

ISOLAMENTO ACUSTICO
ACOUSTIC ABATEMENT
AFFAIBLISSEMENT ACOUSTIQUE

RESISTENZA AL FUOCO
FIRE RESISTANCE
RÉSISTANCE AU FEU

CERNIERA A SCOMPARSA
CONCEALED HINGE
CHARNIÈRE DISSIMULÉE

CERNIERA A VISTA
VISIBLE HINGE
CHARNIÈRE APPARENTE

PIVOT

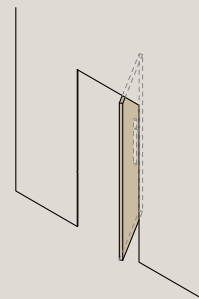

⊕ 4 ⊕ C2
))) 44 dB ⊕ 4
☞ 1 ⊕
⊕ 5B ⊕

IN-WALL

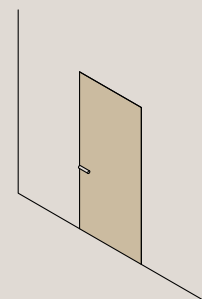

⊕ 4 ⊕ 3
))) 44/45 dB ⊕ C5
☞ 1 ⊕
⊕ 3B/5B ⊕

MATY

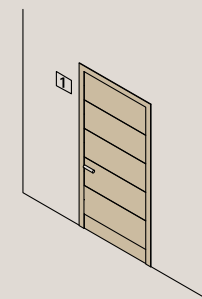

⊕ 3 ⊕ 4
))) 36 dB ⊕ C2
☞ 1,6/1,3 ⊕
⊕ 6B ⊕

PERSEO

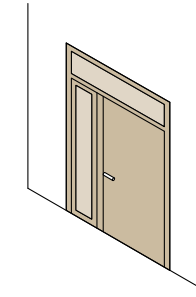

⊕ 4 ⊕ 3
))) 40/43 dB ⊕ C4
☞ 1 ⊕
⊕ 3A

MEDEA

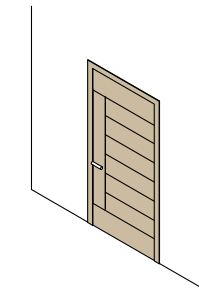

⊕ 3 ⊕ 2/3
))) 40/42 dB ⊕ C4
☞ 1,3 ⊕
⊕ 2A/3A

SIKURA

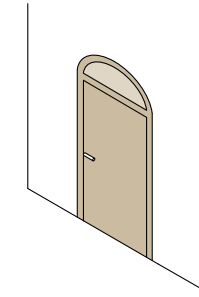

⊕ 4 ⊕ 3
))) 40/43 dB ⊕ C4
☞ 1 ⊕
⊕ 3A

**FLAMMA 60
FUOCO E FUMI**

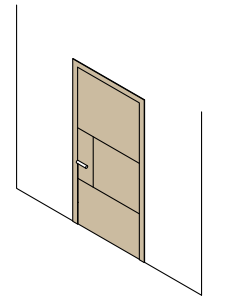

⊕ 3 ⊕ 4
))) 40 dB ⊕ C2
☞ ⊕
⊕ 6 B

PERSEO 3T

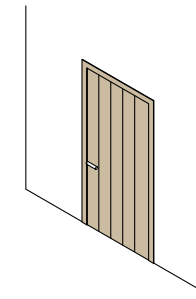

⊕ 4 ⊕ 3
))) 40/42 dB ⊕ C3
☞ 0,7 ⊕
⊕ 3A/7A

MEDEA 3T

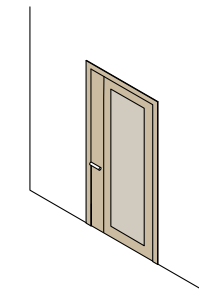

⊕ 3 ⊕ 3
))) 40/42dB ⊕ C3
☞ 0,7 ⊕
⊕ 3A/7A

THERMICS

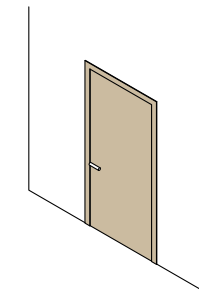

⊕ RC2/3 ⊕ 4
☞ 0,78 ⊕ C4
⊕ 7A ⊕

**FLAMMA 120
FUOCO**

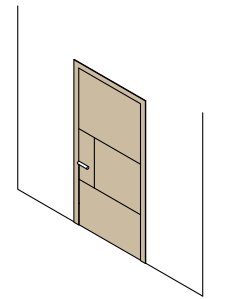

⊕ 4 ⊕ 2
))) 40 dB ⊕ C3
☞ ⊕
⊕ 1B

**ATTENTO DIALOGO
TRA ARCHITETTURA E DESIGN.**

A FOCUSED DIALOGUE BETWEEN
ARCHITECTURE AND DESIGN.

DIALOGUE SOIGNÉ ENTRE
ARCHITECTURE ET DESIGN.



IN_WALL FAMILY LISCI, MODELLO ZENITH, HDF LACCATO
IN_WALL FAMILY SMOOTH, ZENITH MODEL, HDF LACQUERED
IN_WALL FAMILLE LISSE, MODÈLE ZENITH, HDF LAQUÉ



PERSEO 3T . LISCIO . FILO GLASS
PERSEO 3T . SMOOTH . GLASS WIRE
PERSEO 3T . LISSE . FIL DE VERRE

**L'ELEGANZA CHE
ESALTA OGNI STILE.**

ELEGANCE ENHANCING
EVERY STYLE.

L'ÉLÉGANCE QUI AMÉLIORE
TOUS LES STYLES.



IN_WALL . METAL SKIN . EFFETTO PELTRO FERRO
IN_WALL . METAL SKIN . EFFECT PEWTER IRON
IN_WALL . METAL SKIN . EFFET PEWTER IRON



PIVO'T RIVESTIMENTO IN RAME OSSIDATO . MANIGLIONE INCASSATO A DISEGNO
PIVOT AGED COPPER CLADDING . CUSTOM GRIP HANDLE
PIVO'T REVÊTEMENT EN VÉRITABLE CUIVRE VERT-DE-GRIS . POIGNÉE ENCASTRÉE

IL VALORE DI UNA PORTA D'EPOCA CON I PLUS DELLE MODERNE TECNOLOGIE.

MODERN TECHNOLOGY APPLIED ON
A HISTORICAL HERITAGE APPLICATION.

LA VALEUR D'UNE PORTE D'EPOQUE AVEC LES
AVANTAGES DES TECHNOLOGIES MODERNES.

HISTORICO riproduce l'estetica del vecchio portone o su specifico progetto proposto dall'architetto. Ogni fase, dalla progettazione alla realizzazione, è seguita da un team di tecnici esperti che, dal disegno alla selezione dei materiali, dalla valutazione delle essenze legnose fino alla posa in opera, seguono scrupolosamente la sua realizzazione.

Historico is connected to historical architectural heritage with high customization expectations. Every step is carefully pinpointingly looked after starting from the planning stage, through wood species selection, feasibility testing and installation supervision.

HISTORICO reproduit l'esthétique de la porte ancienne ou sur un projet spécifique proposé par l'architecte. Chaque phase, de la conception à la réalisation, est suivie par une équipe de techniciens experts qui suivent scrupuleusement sa réalisation, de la conception à la sélection des matériaux, de l'évaluation des essences de bois jusqu'à la pose.



HISTORICO . RAL 7016



HISTORICO A DISEGNO . TINTA NOCE SU OKOUME'
HISTORICO . OKOUME' STAINED DARK WALNUT
HISTORICO À DESSIN . NOYER TEINTÉ SUR OKOUME'

DY

SARNICO . ITALY



IN_WALL . ZENITH . RAL 7016 . MANIGLIONE CORNER MM.920 . FILO GLASS
 INWALL ZENITH . RAL 7016 . PULL BAR MOD. CORNER 920
 IN_WALL ZENITH RAL 7016 . POIGNÉE DE TIRAGE MOD. CORNER 920 . FILOGLASS



- 1 PORTA PEDONALE
PEDESTRIAN ACCESS
PORTE PALIÈRE
- 24 PORTE DI INGRESSO
APARTMENT DOORS
APARTMENT DOORS
- 24 PORTE GARAGE
PEDESTRIAN ACCESS GARAGE DOORS
PEDESTRIAN ACCESS GARAGE DOORS



PERSEO . ZENITH . ROVERE SPAZZOLATO . MANIGLIONE CORNER MM.920
 PERSEO . ZENITH . BRUSHED OAK . PULL BAR MOD. CORNER 920
 PERSEO . ZENITH . CHÊNE BROSSÉ . POIGNÉE DE TIRAGE MOD. CORNER 920



SECUR CON PORTINA PEDONALE E GRIGLIE DI AREAZIONE
 SECUR PEDESTRIAN DOOR, VENTILATION GRID
 SECUR AVEC PORTILLON ET GRILLES D'AÉRATION



BASCULAP . RONDONIA . RAL 7016

HOUSE CZ

PADOVA . ITALY



PORTA BASCULANTE
E PORTE DI INGRESSO

GARAGE DOOR AND
ENTRANCE DOOR

PORTE DE GARAGE
ET PORTE D'ENTRÉE



PERSEO . ZENITH . RAL 7016
PERSEO . ZENITH . RAL 7016 . PULL BAR MOD. CORNER 920
PERSEO . ZENITH . RAL 7016 . POIGNÉE DE TIRAGE MOD. CORNER 920



X1R SMART SU IN_WALL . NEWMANN . RAL 7016

CA' DELLE ALZAIE

TREVISO . ITALY
STUDIO BOERI

SR PANORAMA CON GRIGLIE AREAZIONE E PORTINA DI SERVIZIO
SR PANORAMA WITH ACCESS DOOR AND VENTILATION GRIDS
SR PANNEAU RONDONIA AVEC GRIS DE VENTILATION



3 PORTE PEDONALI
ACCESS DOORS
PORTE PALIÈRE

60 PORTE DI INGRESSO
APARTMENT DOORS
PORTES D'ENTRÉE

74 PORTE GARAGE
GARAGE DOORS
PORTES DE GARAGE



IN_WALL INTONACATA RASOMURO ESTERNO E FASCIONE BRONZO
INWALL PLASTERED, FLUSH WITH EXTERNAL WALL, WITH BRONZE VERICAL FASCIA
IN_WALL PLÂTRÉE, AFFLEURANTE EXTÉRIEUR, AVEC BANDE MÉTALLIQUE VERTICALE BRONZE



SR PANNELLO RONDONIA . RAL 7006 CON GRIGLIE AREAZIONE
SR RONDONIA PANELS . RAL 7006 WITH VENTILATION GRIDS
SR PANORAMA AVEC PORTILLON ET GRIS DE VENTILATION

**SAPPIAMO COME TRASFORMARE
LE IDEE IN REALTÀ.**

WE LET IDEAS BECOME REALITY.

NOUS SAVONS COMMENT TRANSFORMER
DES IDÉES EN RÉALITÉ.

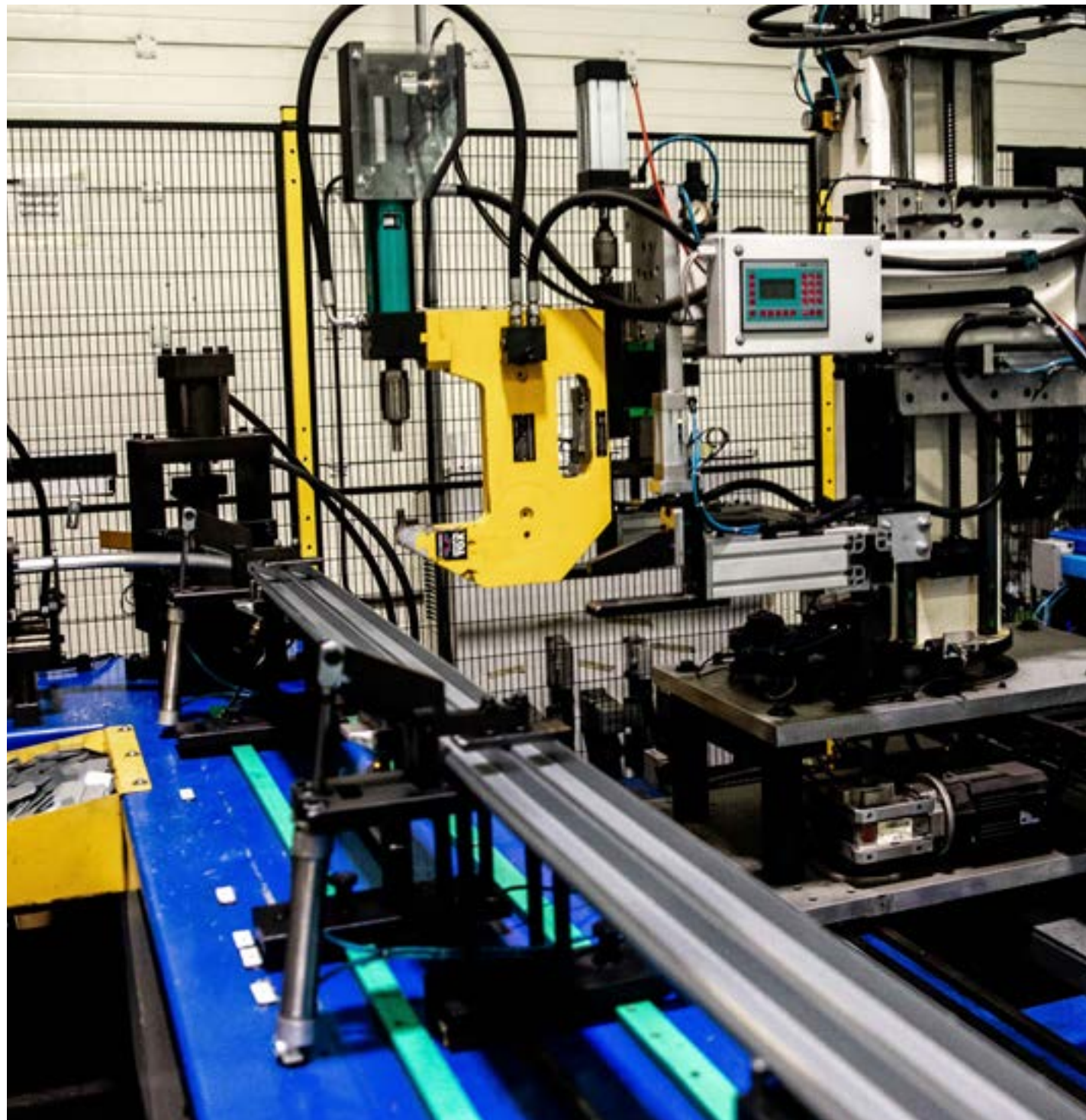

100% MADE IN ITALY
100% MADE IN ITALY
100% MADE IN ITALY



RICERCA E SVILUPPO
RESEARCH AND DEVELOPMENT
RECHERCHE ET DÉVELOPPEMENT



L'ARTE DEL LEGNO
WOODWORKING MASTERY
L'ART DU BOIS

Siamo inseriti in una supply chain totalmente italiana. Progettiamo e ingegnerizziamo i prodotti al nostro interno con una solida passione per la lavorazione del legno. Grazie al nostro laboratorio interno, affianchiamo architetti e progettisti nella progettazione delle soluzioni, adattando le nostre proposte o prototipandone di nuove. Predisposti per natura alla crescita, implementiamo all'occorrenza i nostri processi produttivi per rispondere a qualsiasi esigenza progettuale e di mercato.

Our supply chain is local. Our in house Research and Development team tightly cooperates with suppliers, interacts with architects or project managers to define specific solutions or even prototypes. This attitude allow us to embrace various execution necessities that markets demand.

Nous faisons partie d'une chaîne d'approvisionnement totalement italienne. Nous concevons et fabriquons des produits en interne avec une solide passion pour le travail du bois. Grâce à notre laboratoire interne, nous accompagnons les architectes et designers dans la conception de solutions, adaptant nos propositions ou en prototypant de nouvelles. Prédisposés par nature à la croissance, nous mettons en œuvre nos processus de production lorsque cela est nécessaire pour répondre à toute exigence de conception et de marché.

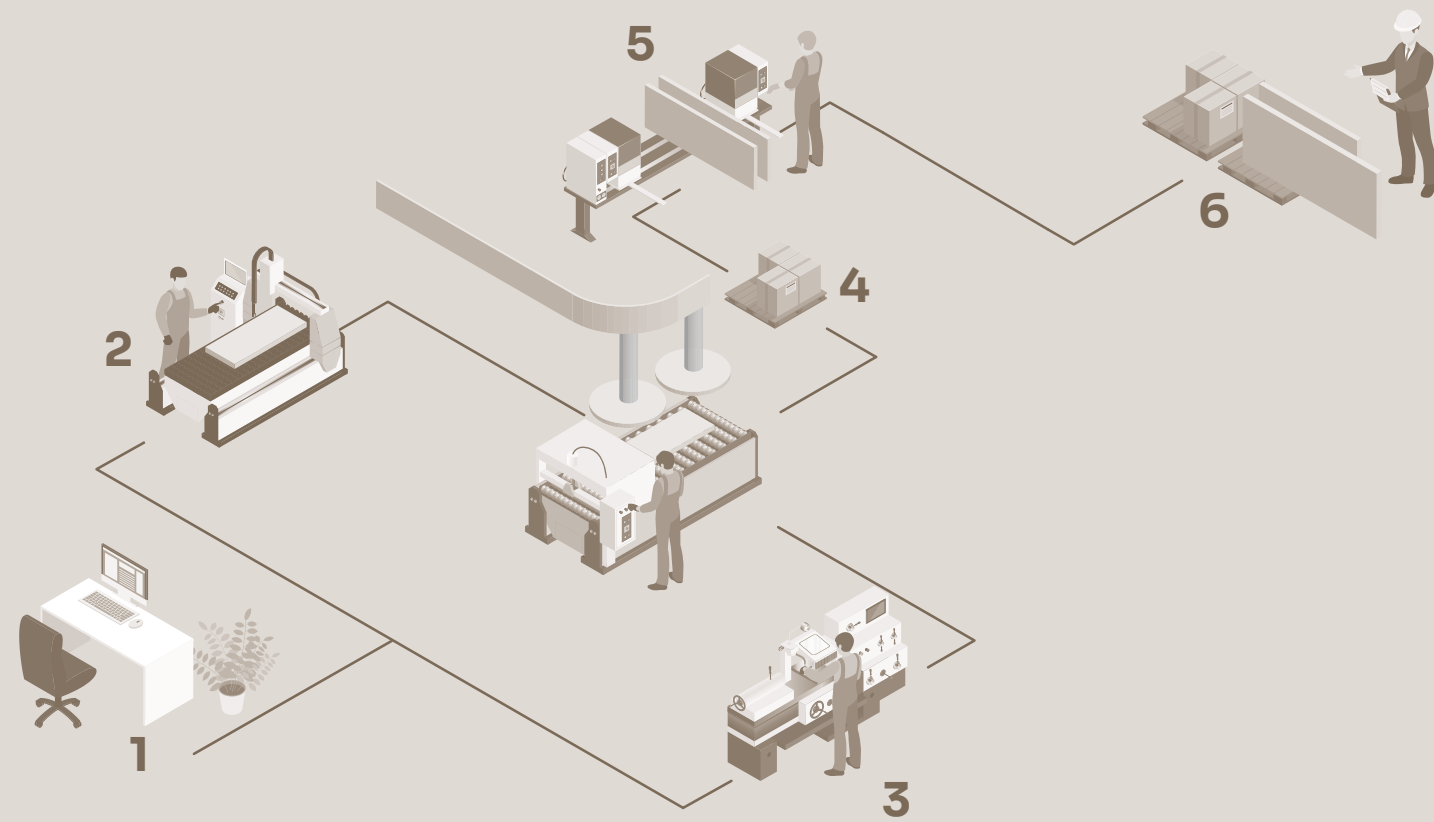

1
RICERCA E SVILUPPO
 RESEARCH AND DEVELOPMENT
 RECHERCHE ET DÉVELOPPEMENT

2
LAVORAZIONE LEGNO E VERNICIATURA WOOD
 WORKING AND VARNISHING
 TRAVAIL DU BOIS ET PEINTURE

3
LAVORAZIONE METALLI E VERNICIATURA
 METAL CARPENTRY AND VARNISHING
 TRAVAIL MÉTAUX ET PEINTURE

UNA PRODUZIONE SENZA LIMITI. IL CICLO COMPLETO IN AZIENDA.

FLEXIBLE PRODUCTION. THE WHOLE PRODUCT CREATION PROCESS IS ACCOMPLISHED IN OUR FACTORY.

UNE PRODUCTION SANS LIMITES. LE CYCLE COMPLET DANS L'ENTREPRISE.



L'alta automatizzazione dei processi e l'industrializzazione del ciclo produttivo, favoriscono elasticità, elevati standard di efficienza produttiva e tempi di consegna ridotti, garantendo sempre l'alto livello qualitativo dei prodotti e del servizio.

A highly automated production process sustains our elasticity, productivity to the highest levels and allows rapid execution timing.

La forte automatisation des processus et l'industrialisation du cycle de production favorisent la flexibilité, des normes élevées d'efficacité de production et des délais de livraison réduits, garantissant toujours le haut niveau de qualité des produits et du service.

4
COMPONENTI ACCESSORI
 COMPONENTS INCORPORATION
 COMPOSANTS ACCESSOIRES

5
ASSEMBLAGGIO
 ASSEMBLY
 ASSEMBLAGE

6
COLLAUDO E SPEDIZIONE
 TESTING AND SHIPPING
 TEST ET LIVRAISON

**CI SIAMO IN OGNI FASE: DALLA PROGETTAZIONE,
ALL'INSTALLAZIONE, ALL' ASSISTENZA POST VENDITA.**

PRESENT AT ANY STAGES: FROM PLANNING, THROUGH
INSTALLATION AID AND POST SALES SERVICE.

NOUS SOMMES LÀ À CHAQUE PHASE: DE LA CONCEPTION,
À L'INSTALLATION, JUSQU'À L'ASSISTANCE APRÈS-VENTE.



Abbiamo una fitta rete di referenti nel mercato sui quali fare affidamento e ai quali rivolgersi, in ogni momento: dalla progettazione, all'installazione, all'assistenza post vendita. Mettiamo a disposizione dei nostri clienti ampi Showroom espositivi, sale formazione, video tutorial per guidare all'installazione, configuratore di prodotto online assieme a un importante archivio fotografico, materiali di assistenza tecnica, cataloghi e presentazioni digitali.

Our sales and technical network help supporting clients through various phases. Project, installation, post-installation necessities. A mix of marketing and technical tools are available to aid our partners' business success and development (tutorial videos, on-line configurator, training program, factory showrooms).

Nous disposons d'un réseau dense de contacts sur le marché sur lequel nous pouvons compter et auquel nous pouvons faire appel à tout moment: de la conception à l'installation et au service après-vente. Nous mettons à la disposition de nos clients de vastes salles d'exposition, des salles de formation, des tutoriels vidéo pour les guider dans l'installation, un configurateur de produits en ligne ainsi que d'importantes archives photographiques, du matériel d'assistance technique, des catalogues et des présentations numériques.



**VANTIAMO UN IMPORTANTE PORTAFOGLIO
DI BREVETTI NAZIONALI ED INTERNAZIONALI.**

**WE ARE PROUD OF OUR NATIONAL
AND INTERNATIONAL PATENTS.**

**NOUS AVONS UN PORTEFEUILLE IMPORTANT
DE BREVETS NATIONAUX ET INTERNATIONAUX.**



**PORTA SEZIONALE CON
PASSAGGIO PEDONALE**

PEDESTRIAN/WICKET
DOOR APPLIED

ON SECTIONAL DOORS
PORTE SECTIONNELLE AVEC
PASSAGE PIÉTONS



**CERNIERA PORTA
BLINDATA PIVOT**

PIVOT SECURITY
DOOR HINGE

CHARNIÈRE DE PORTE
BLINDÉE À PIVOT



**SISTEMA SCORRIMENTO
ARCHITRAVE 150 MM**

ROLLING MECHANISM WITHIN
150 MM ON ARCHITRAVE

SYSTÈME COULISSANT
LINTEAU 150 MM



**TECNOLOGIA
OVERLAP**

OVERLAP
TECHNOLOGY

TECHNOLOGIE
OVERLAP



**SISTEMA SICUREZZA
A PARACADUTE**

“PARACHUTE”
SAFETY SYSTEM

SYSTÈME DE SÉCURITÉ
PARACHUTE



**KIT DI MONTAGGIO
PORTA GARAGE**

UP AND OVER GARAGE
DOORS AS KIT

KIT DE MONTAGE
PORTE DE GARAGE



**CARTER COPRIMOLLA
PER MOLLE SEZIONALI**

SECTIONAL DOORS
TORSION SPRINGS COVER

CARTER DE COUVERCLE
DRESSOR POUR RESSORTS
SECTIONNELS

L'innovazione tecnologica è elemento essenziale della strategia di Silvelox Group. Investiamo costantemente risorse in progetti di Ricerca e Sviluppo: è qui che le richieste di tutti i nostri clienti vengono analizzate e dalle quali nascono nuovi concetti o personalizzazioni di sistemi Silvelox.

Innovation is at center of our company vision. We regularly invest on Research and Development where we absorb information over specific requests that give birth to the most varying customization.

L'innovation technologique est un élément essentiel de la stratégie de Silvelox Group. Nous investissons constamment des ressources dans des projets de Recherche et Développement: c'est ici que les demandes de tous nos clients sont analysées et d'où naissent de nouveaux concepts ou personnalisations de systèmes Silvelox.

**CERTIFICHIAMO I NOSTRI PRODOTTI
AGLI STANDARD PIÙ ELEVATI.**

**OUR PRODUCTS ARE CERTIFIED
TO THE HIGHEST STANDARDS.**

**NOUS CERTIFIONS NOS PRODUITS
AUX STANDARDS LES PLUS HAUT.**

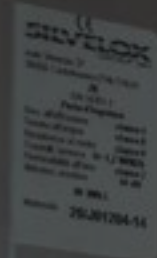

**ISOLAMENTO
TERMICO**
THERMAL
INSULATION
ISOLATION
THERMIQUE



ANTIEFFRAZIONE
SECURITY
ANTI-EFFRACTION



**TENUTA
ALL'ACQUA**
WATER TIGHTNESS
ÉTANCHÉITÉ À L'EAU



**ISOLAMENTO
ACUSTICO**
ACOUSTIC
ABATEMENT
AFFAIBLISSEMENT
ACOUSTIQUE



**TENUTA AL VENTO
E ALL'ARIA**
WIND AND AIR
TIGHTNESS
ÉTANCHÉITÉ AU
VENT ET À L'AIR



**RESISTENZA
AL FUOCO**
FIRE RESISTANCE
RÉSISTANCE AU FEU

Tutti i nostri prodotti sono testati presso il nostro laboratorio e Laboratori Notificati al fine di valutare una serie di criteri prestazionali quali la tenuta all'acqua, al vento e all'aria, la durabilità, isolamento termico e acustico, antieffrazione, la resistenza al fuoco, la tenuta ai fumi.
Un esempio di eccellenza è Secur Plus, la prima porta per garage in legno ad aver superato tutti i test richiesti dalla Norma Europea ENV 1627 relativamente alla CLASSE 3 di antieffrazione.

Our products are tested in-house and certified by Qualified External Labs to value Air, Water, Wind tightness, sound abatement, anti burglar performances, fire rating. An example of excellence in our SECURPLUS. The only timber garage door certified in security class 3 by the EN 1627 European Regulation

L'innovazione tecnologica è un elemento essenziale della strategia di Silvelox Group. Nous investissons constamment des ressources dans des projets de Recherche et Développement : c'est ici que les demandes de tous nos clients sont analysées et d'où naissent de nouveaux concepts ou personnalisations de systèmes Silvelox.

**SILVELOX TRASFORMA LE PORTE
IN AUTENTICHE OPERE D'ARTE,
CREANDO PEZZI UNICI CON MAESTRIA
ARTIGIANALE CHE CONFERISCONO
UN TOCCO DI BELLEZZA SENZA PARI
ALLA TUA CASA.**

SILVELOX TRANSFORMS DOORS INTO
GENUINE WORKS OF ART, CREATING
UNIQUE PIECES WITH ARTISANAL
MASTERY THAT ADD AN UNPARALLELED
TOUCH OF BEAUTY TO YOUR HOME.

SILVELOX TRANSFORME LES PORTES
EN VÉRITABLES ŒUVRES D'ART,
CRÉANT DES PIÈCES UNIQUES AVEC
UN SAVOIR-FAIRE ARTISANAL QUI
APPORTENT UNE TOUCHE DE BEAUTÉ
INÉGALÉE À VOTRE MAISON.

COLORE IN CITTÀ
tempera su tela
50x40 cm - 2020
Lucrezia Lamberti

COLOR IN THE CITY
tempera on canvas
50x40 cm - 2020
by Lucrezia Lamberti



Lucrezia Lamberti

CONNECT

**ART DIRECTION &
PROGETTO GRAFICO**
Roberto Papparotto

PRINT
LitoDelta

SILVELOX
GROUP SPA

SILVELOX GROUP SPA

**HEADQUARTERS AND
PRODUCTION PLANT**

Viale Venezia, 37
38050 Castelnuovo
Trento - Italy
T. +39 0461 755 755
F. +39 0461 752 466

info@silvelox.it
www.silvelox.it

PRODUCTION PLANT

Via Rossi, 14
25010 Remedello
Brescia - Italy
T. +39 030 258 5500
F. +39 030 258 2537

info@silvelox.it
www.silvelox.it